

VC-B10U
HD Camera
(USB 3.0 Camera)

Installation Manual - English



[Important]

To download the latest version of Quick Start Guide, multilingual user manual, software, or driver, etc., please visit Lumens
<http://www.MyLumens.com>

Table of Contents

Copyright Information	2
Chapter 1 Safety Instructions	3
Chapter 2 Package Contents	5
Chapter 3 Product Overview	6
3.1 Overview.....	6
3.2 Description of LED indicator	7
3.3 System Requirements	7
Chapter 4 Instruction for installation	8
4.1 Instruction for installation.....	8
4.2 Connecting the device	10
Chapter 5 Remote Control Buttons Descriptions	11
Chapter 6 Descriptions of Major Functions	12
6.1 I would like to control the camera.....	12
6.2 I would like to use Skype for video conference	12
6.3 I would like to save the current screen position data	12
6.4 I would like to clear the saved position data.....	12
6.5 I would like to adjust the brightness of the image	12
6.6 I would like to adjust the direction of the screen shot.....	13
6.7 I would like to zoom in/out images	13
6.8 I would like to freeze images	13
6.9 I want to restore the Factory Reset	13
Chapter 7 DIP switch setting	14
Chapter 8 Troubleshooting	15
Supplier's Declaration of Conformity 47 CFR § 2.1077 Compliance Information	16

Copyright Information

Copyrights © Lumens Digital Optics Inc. All rights reserved.

Lumens is a trademark that is currently being registered by Lumens Digital Optics Inc.

Copying, reproducing or transmitting this file is not allowed if a license is not provided by Lumens Digital Optics Inc. unless copying this file is for the purpose of backup after purchasing this product.

In order to keep improving the product, Lumens Digital Optics Inc. hereby reserves the right to make changes to product specifications without prior notice. The information in this file is subject to change without prior notice.

To fully explain or describe how this product should be used, this manual may refer to names of other products or companies without any intention of infringement.

Disclaimer of warranties: Lumens Digital Optics Inc. is neither responsible for any possible technological, editorial errors or omissions, nor responsible for any incidental or related damages arising from providing this file, using, or operating this product.

Chapter 1 Safety Instructions

Always follow these safety instructions when setting up and using the product:

1 Operation

- 1.1 Please use the product in the recommended operating environment.
- 1.2 Do not place the product in tilted position.
- 1.3 Do not place the product on an unstable trolley, stand or table.
- 1.4 Do not use this product near water or source of heat.
- 1.5 Use attachments only as recommended.
- 1.6 Use the type of power source indicated on the product. If you are not sure of the type of power available, consult your distributor or local electricity company for advice.
- 1.7 Always take the following precautions when handling the plug. Failure to do so may result in sparks or fire:
 - Ensure the plug is free of dust before inserting it into a socket.
 - Ensure that the plug is inserted into the socket securely.
- 1.8 Do not overload wall sockets, extension cords or multi-way plug boards to avoid potential risks.
- 1.9 Do not block the slots and openings in the case of the product. They provide ventilation and prevent the product from overheating.
- 1.10 Except as specifically instructed in this User Manual, do not attempt to operate this product by yourself. Opening or removing covers may expose you to dangerous voltages and other hazards. Refer all servicing to licensed service personnel.
- 1.11 Unplug the product from the wall outlet and refer servicing to licensed service personnel when the following situations happen:
 - If the power cords are damaged or frayed.
 - If liquid is spilled into the Product or the Product has been exposed to rain or water.

2 Installation

- 2.1 For security considerations, please make sure the standard hanging rack you bought is in line with UL or CE safety approbations and installed by technician personnel approved by agents.

3 Storage

- 3.1 Do not place the Product where the cord can be stepped on as this may result in fraying or damage to the lead or the plug.
- 3.2 Never push objects of any kind through cabinet slots. Never allow liquid of any kind to spill into the Product.
- 3.3 Unplug this product during thunderstorms or if it is not going to be used for an extended period.
- 3.4 Do not place this product or accessories on top of vibrating equipment or heated objects.

4 Cleaning

- 4.1 Unplug all the cables before cleaning. Use a damp cloth for cleaning. Do not use liquid or aerosol cleaners.





5 Remote control (if the accessories are equipped with remote control)

- 5.1 Using an incorrect battery type in the remote control may result in breakdown. Follow local instructions on how to dispose of used batteries.

■ Precautions

Warning: To reduce the risk of fire or electric shock, do not expose this appliance to rain or moisture.

If the HD camera will not be used for an extended time, unplug it from the power socket.

	<p>Caution</p> <p>Risk of Electric Shock</p> <p>Please do not open it by yourself</p>		
<p>Caution: To reduce the risk of electric shock, do not remove cover (or back). No user-serviceable parts inside. Refer servicing to licensed service personnel.</p>			
	<p>This symbol indicates that this unit may contain dangerous voltage which could cause electric shock.</p>		<p>This symbol indicates that there are important operating and maintenance instructions in this User Manual with this unit.</p>

■ FCC Warning

This HD camera has been tested and found to comply with the limits for a Class A digital device, pursuant to Article 15-J of FCC Rules. These limits are designed to provide reasonable protection against harmful interference in a commercial installation.

This digital apparatus does not exceed the Class A limits for radio noise emissions from digital apparatus as set out in the interference-causing equipment standard entitled "Digital Apparatus," ICES-003 of Industry Canada.

Cet appareil numérique respecte les limites de bruits radioélectriques applicables aux appareils numériques de Classe A prescrites dans la norme sur le matériel brouilleur: "Appareils Numériques," NMB-003 édictée par l'Industrie.

This device complies with Part 15 of the FCC Rules, Operation is subject to the following two conditions: (1) this device may not cause harmful interference, and (2) this device must accept any interference received, including interference that may cause undesired operation.

■ EN55032 (CE Radiation) Warning

Operation of this equipment in a residential environment could cause radio interference.

Chapter 2 Package Contents

VC-B10U



TV stand



Instruction for
installation



Remote Control

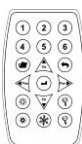

USB cable (USB 3.0)



Chapter 3 Product Overview

3.1 Overview

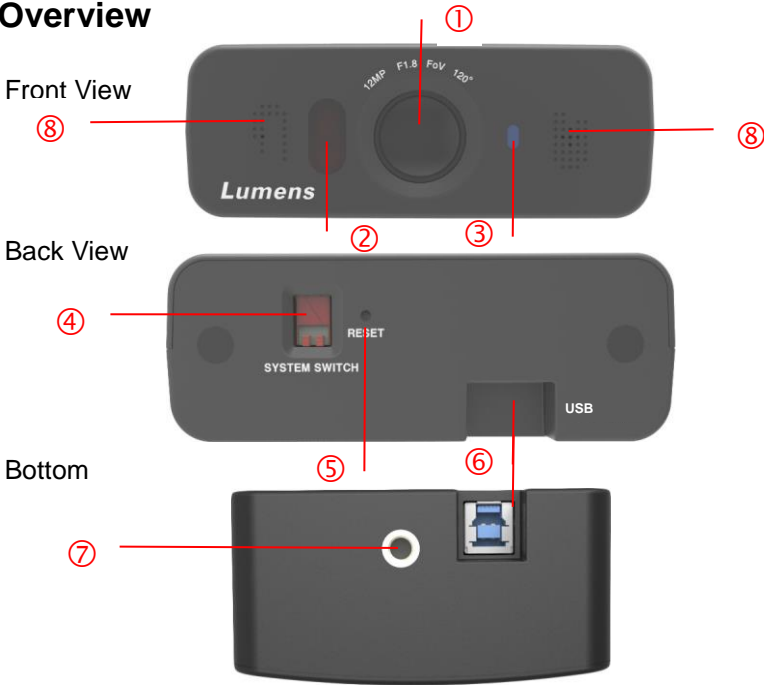

1. Camera lens	2. IR reception
3. Power LED indicator	4. SYSTEM SWITCH
5. RESET (Restore the Factory Reset)	6. USB 3.0 Port
7. Tripod mount lock hole	8. Omni-directional microphone

3.2 Description of LED indicator

- 3.2.1 No Light: Power off
- 3.2.2 Stable red light: In standby mode
- 3.2.3 Stable blue light: Power on already or Preview
- 3.2.4 Blinking blue light: Infrared remote control signal received

3.3 System Requirements

- 1.Windows System: Windows 7 or above
- 2.Chrome system
- 3.MAC System:Support Mac OS X 10.8 or above
- 4. Android system: Android OS 5.0 or above

<Remark> When connecting to MAC OS, please refer to [Chapter 7 DIP Switch Setting](#), to modify DIP Switch

Chapter 4 Instruction for installation

4.1 Instruction for installation

4.1.1 I would like to install the camera on top of the TV screen

Use the included TV stand to install the camera on top of the TV screen

4.1.1.1 Installation steps

1. Connect to USB cable

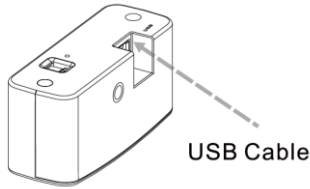

2. Release the mounting clip stand. Align the stand knob with the locking hole on VC-B10U, and then secure the knob

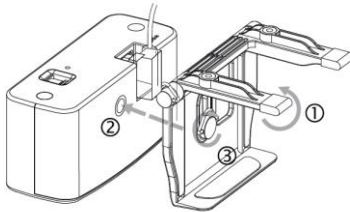

3. Place the TV mounting clip stand on the top of a TV set. Adjust angle and then secure the clip knob firmly to prevent from falling off

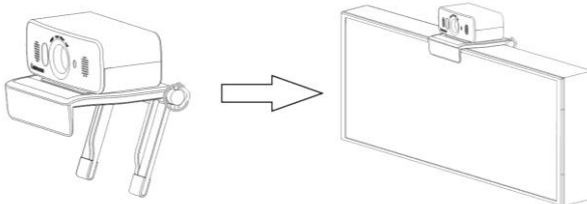

4.1.2 I would like to install camera on the wall

Use the included TV stand to install the camera on top of the TV screen

4.1.2.1 Installation steps

1. Use the provided screws to secure the mounting stand on the wall

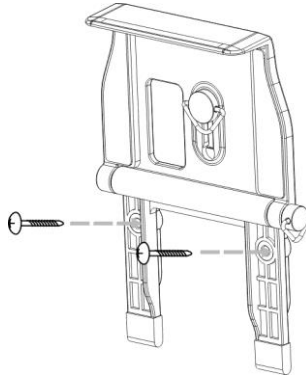

2. Connect the USB cable and secure the clip knob firmly to prevent it from falling off

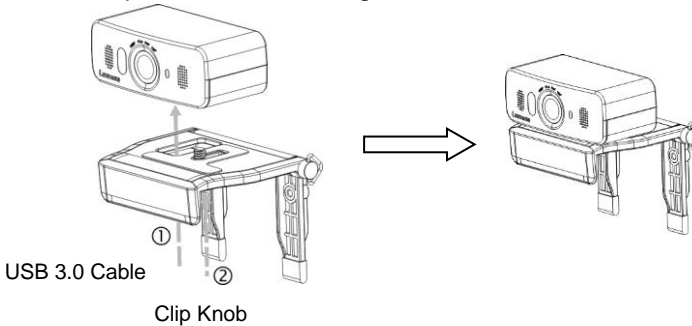

4.2 Connecting the device

4.2.1 Video Conference --- Connecting to PC

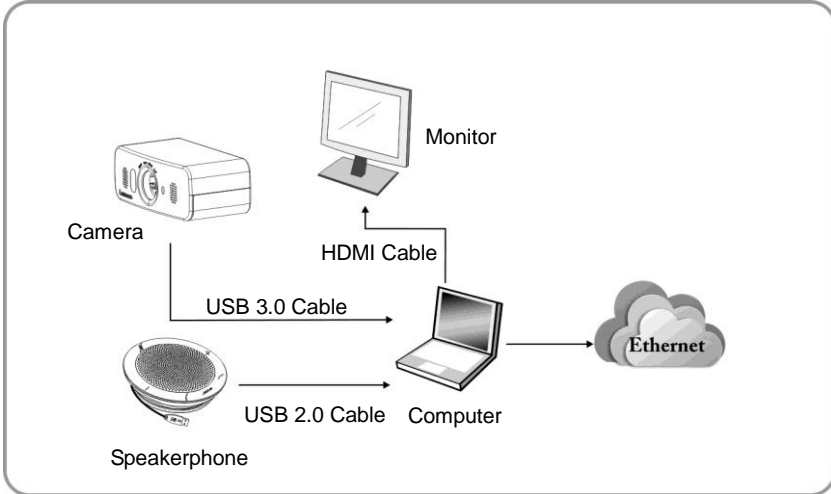

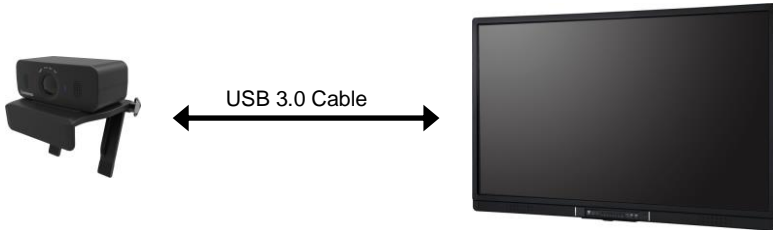

4.2.2 Connect to the touchscreen TV/touchscreen display



<Remark> Download video conference software suited for the touchscreen TV from App Store for operation

Chapter 5 Remote Control Buttons Descriptions

<Remark>The below functions are listed alphabetically.

	Item	Description
	Preset	Appoint an ID (0 ~ 9) to save the current position data
	Reset	Appoint an ID (0 ~ 9) to delete the current position data
	Zoom + / -	Increase or decrease the image size
	Home	The screen returns to the default size
		Change the screen direction; use Zoom+ to see a larger image and adjust afterward
	Pan Right	Adjust the screen direction to the right
	Pan Left	Adjust the screen direction to the left
	Tilt Up	Adjust the screen direction up
	Tilt Down	Adjust the screen direction down
	BRT + / -	Adjust the brightness of the image
	Freeze	Freeze the screen

Chapter 6 Descriptions of Major Functions

6.1 I would like to control the camera

VC-B10U can be controlled using “USB PTZ Camera Controller” software. Please download software from the Lumens website and [USB PTZ Camera Controller Manual](#).

6.2 I would like to use Skype for video conference

Please refer to [Chapter 4 Instruction for installation](#) to complete connecting VC-B10U with the computer. Start Skype; select the contact; press  to begin the video conference.

If it doesn't work, please refer to the following steps to setup the camera:

1. Start Skype -> [Function] -> [Audio and Video Setting]
2. Select [Lumens VC-B10U Video Camera] from the Camera list and press [Enter]

After the setting is completed, the video conference is ready to begin

6.3 I would like to save the current screen position data

1. Use the **remote control**; press [**Preset**]key and press [**ID**] within 3 seconds to store data of the current position.
 - ID shall be a digit [1 ~ 6].

6.4 I would like to clear the saved position data

1. Use the **remote control**; press [**Reset**] key and press [**ID**] within 3 seconds to clear data of the designated position.
 - ID shall be a digit [1 ~ 6].

6.5 I would like to adjust the brightness of the image

1. Use the **remote control**; press [**BR +**]to increase the brightness
2. Use the **remote control**; press [**BR -**]to reduce the brightness

6.6 I would like to adjust the direction of the screen shot

1. Press **[Tilt ▲]** or **[Tilt ▼]** on the **remote control** to adjust the angle upward or downward.
2. Press **[Pan ►]** or **[Pan ◀]** on the **remote control** to adjust the angle to the right or left.

6.7 I would like to zoom in/out images

1. Press **[Zoom +]** on the **remote control** to zoom in images.
2. Press **[Zoom -]** on the **remote control** to zoom out images.

6.8 I would like to freeze images

1. Press **[Freeze]** on the **remote control** to freeze the current image on the display.

6.9 I want to restore the Factory Reset

1. Start the USB screen. Press and hold **RESET** on the back of the device for 3 seconds to restore the Factory Reset
2. Use the **remote control**; press and hold **[Home]** for 3 seconds to restore the Factory Reset

Chapter 7 DIP switch setting

<Note> Please turn off the machine before changing DIP switch setting.

7.1 SYSTEM SWITCH

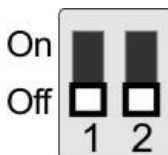

Setting	Function Descriptions
DIP 1	Bulk / ISO Mode OFF : Bulk Mode / ON : ISO Mode
DIP 2	Power Frequency OFF : 60Hz / ON : 50Hz

<Remark>

Mac OS X 10.8 、 10.9 : DIP1 ON

Mac OS X 10.10 or above : DIP1 OFF

Chapter 8 Troubleshooting

This chapter describes the problems you may encounter while using VC-B10U. If you have questions, please refer to related chapters and follow all the suggested solutions. If the problem still occurred, please contact your distributor or the service center.

No.	Problems	Solutions
1.	There is no image output from VC-B10U	<ol style="list-style-type: none">1. Replace the USB cables and make sure they are not faulty.2. Verify whether the computer or equipment has detected the VC-B10U camera and is connected correctly.
2.	VC-B10U cannot be operated by remote control	<ol style="list-style-type: none">1. Please confirm that VC-B10U has been connected to the computer, and launch video software.2. Please verify the VC-B10U LED indicator. When the signal received by the device is normal, the LED indicator will flash.
3.	When connected to the MAC computer, the video screen flicker or freeze	Please confirm that DIP Switch-DIP1 at the base of the camera is switched to "ON" when using Mac OS X 10.10 or earlier
4.	VC-B10U output resolution is low	The default output resolution of VC-B10U is 640X480. Please go to the connected video conference software setting and adjust the video conference output resolution. (Note: Some video conference software do not have the option of adjusting the resolution: such as Skype)

Supplier's Declaration of Conformity 47 CFR § 2.1077 Compliance Information

Manufacturer : Lumens Digital Optics Inc.

Product Name : VC-B10U

Model Number : USB 3.0 Camera

Responsible Party – U.S. Contact Information

Supplier : Lumens Integration, Inc.

4116 Clipper Court, Fremont, CA 94538, United States

e-mail : support@mylumens.com

FCC Compliance Statement

This device complies with Part 15 of the FCC Rules. Operation is subject to the following two conditions : (1) This device may not cause harmful interference, and (2) this device must accept any interference received, including interference that may cause undesired operation.